

# ASSEMBLE INSTRUCTION







## ITEM NO :5910VESP ROCKING CHAIR

\*\* Thank you for purchasing quality product.Be sure to check all packing material carefully for small parts that may have came loose inside the carton during shipment.













Note:place all wooden parts on a clean and smooth surface such as a rug or carpet to avoid scatching the product .Kindly follow the assembly instructions by step.

Do not tighten all screws and bolts until the chair is fully assemble.

### WOODEN PART

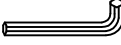
No	Parts name	Symbol	Qty
1	Back Chair		1Pc
2	Arm (R)		1Pc
3	Arm (L)		1Pc
4	Front leg (R)		1Pc
5	Front leg (L)		1Pc
6	Seat		1Pc
7	Runner		2Pcs

### HARDWARE LIST

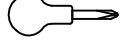
No	Parts name	Symbol	Qty
A	Bolt 1/4"x50 mm		4Pcs
B	Spring washer 1/4"*10.5		4Pcs
C	Flat washer 1/4"*12		4Pcs
D	Bolt 5/16"x75 mm		4Pcs
E	Bolt 5/16"x50 mm		4Pcs
F	Bolt 5/16"x38 mm		3Pcs
G	Spring washer 5/16x13		11Pcs
H	Flat washer 5/16"x19		11Pcs
I	Allen key		1Pc
J	Screw #4x38mm		2Pcs
K	Screw #3x15mm		4Pcs
L	Brass plate		2Pcs
M	Drawer(not included)		1Pc

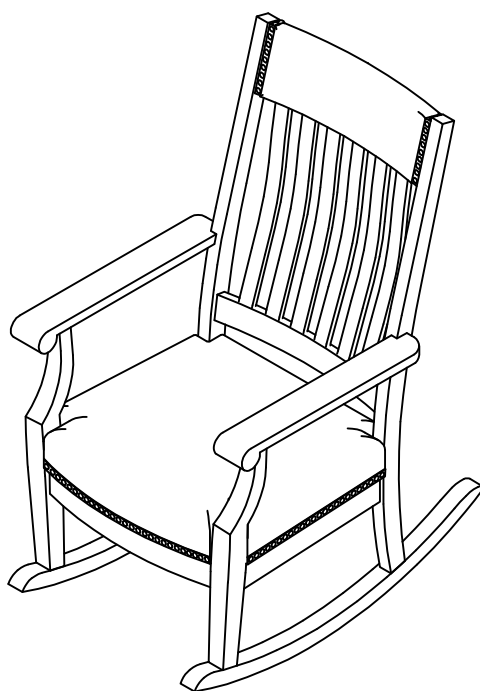

# ASSEMBLE INSTRUCTION

## ITEM NO :5910VESP ROCKING CHAIR

Step 1

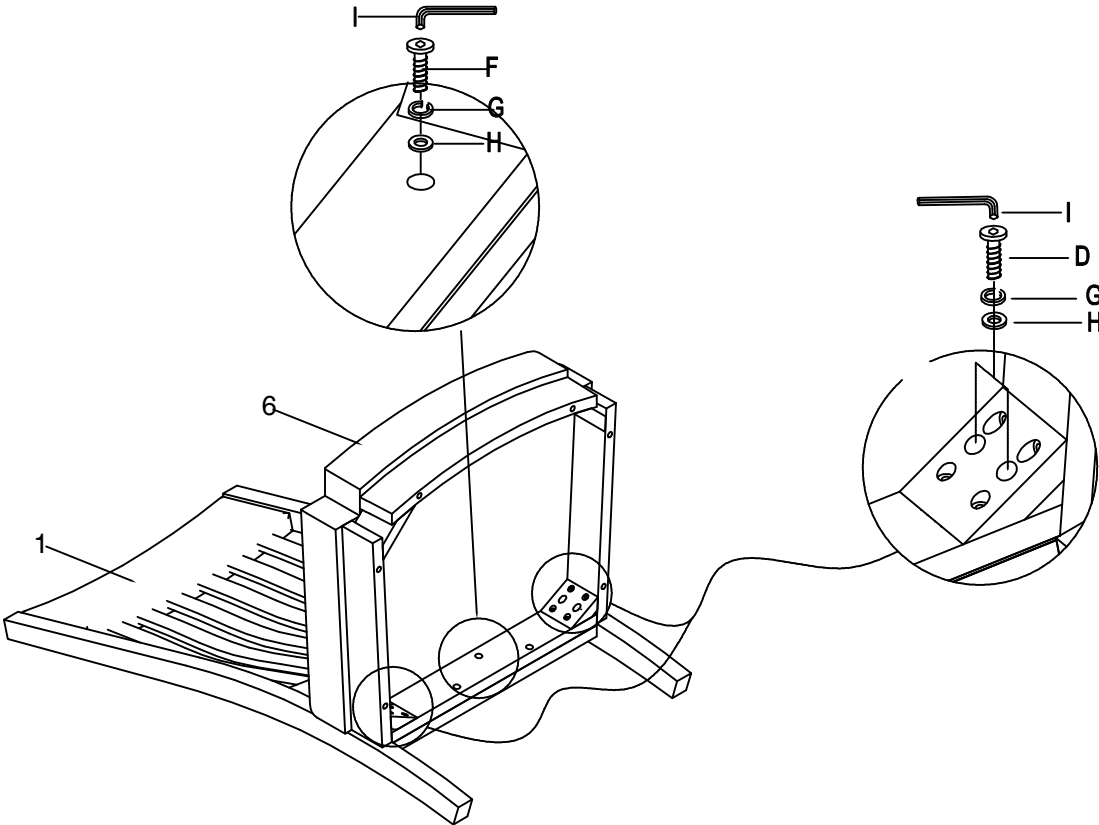

Step 2

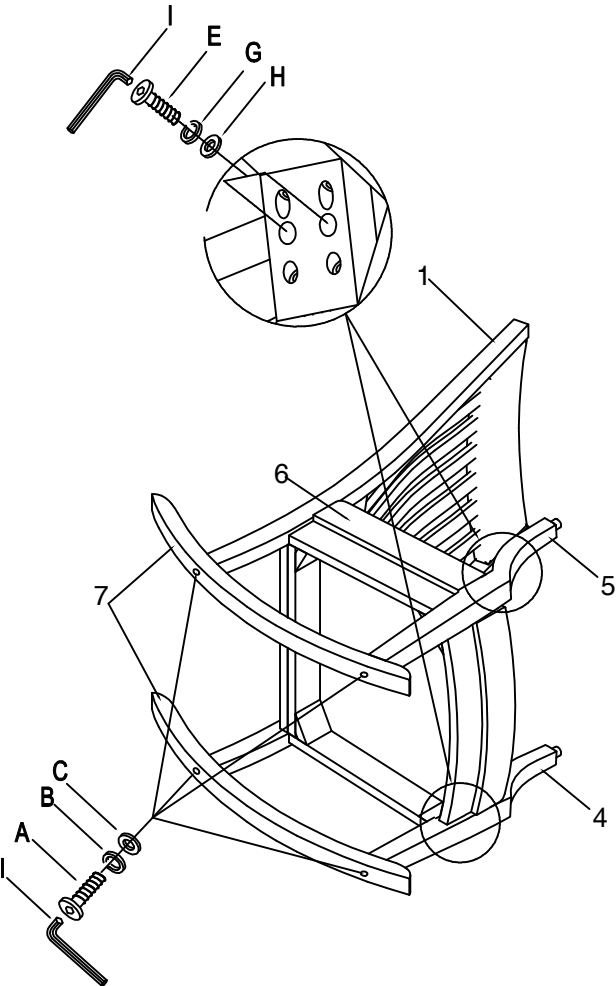

Step 3

